



自动升降系统

Product Guide 2024













对于高空LED照明·插座·CCTV, 火灾探测器·通风设备和宣传横幅来说·自动升降系统现已成为必需品！

适用于体育馆·地铁站·工厂·物流仓库·科学室·实验室·游泳馆·教会·教堂

结婚礼堂·宴会厅·酒店·机场·发电站·展厅等场所

自动升降系统











基本型号

									
MSI-3	MDI-5	CSI-12	CDI-15	HSI-18	HDI-25	PSI-20	PSI-30	PDI-35	PDI-50

插座升降器

									
PFI-100	PFI-200	PFI-300	PFI-500	即将推出	LSI-7	LSI-10	LSI-PS	LSI-3	LDI-3



多触点升降器

									
MSI-1M	MDI-5M	CSI-12M	CDI-15M	HSI-18M	HDI-25M	PSI-20M	PDI-35M	PSI-30M	PDI-50M



CCTV升降产品

					
MSI-1CH	MDI-5CH	CSI-7CH	CDI-12CH	HSI-12CH	HDI-25CH

同步升降器

		
适用全部型号	通风设备升降器	多触点同步升降器





横幅&屏风&防疫隔离板

		
BDL-2	BDL-2D	BDL-4D

火灾探测器 筒灯 升降槽

		
FSI-1	筒灯升降器	升降槽

控制装置

				
RT-RCU	RT-IR	RT-WS	RT-WLS	R-WP







LED泛光灯

							
RT-LEDN150	RT-LEDN200	MSI-LN150	MSI-LN200	CSI-LN150	CSI-LN200	CSI-7D150	CSI-7D200

室外用可升降LED

CSI-LH200

太阳能路灯

 独立型	 独立型	 独立型	 发电型	 发电型	 发电型
RT-SLL	RT-SLCL	RT-SLC2L	RT-SLLK	RT-SLCLK	RT-SLC2LK

升降系统的安全装置



安全锁住装置

升降器内设有锁住装置，锁住状态可以承重1吨，可防止特殊情况出现钢丝绳下滑而导致灯具坠落，升降器自锁时，钢丝绳处于松弛状态不受力，不受损。

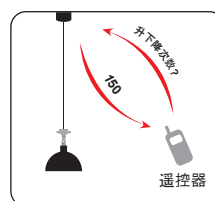

钢丝绳检查功能

通过遥控器可以查看升降器升降累计的次数。

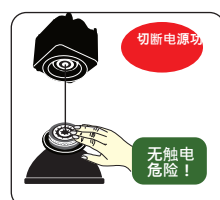

防触电功能

即使在照明开启的状态下降，也会立即断电，下降后进行维护时，无触电危险。

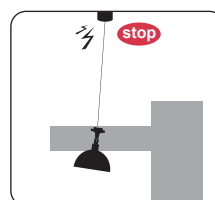

超负荷感应装置

升降器升降过程中，遇到障碍物时，会自动停止升降动作。

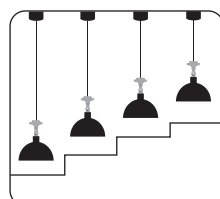

下降定位功能

用遥控器预定停止位置以后，升降器则会在预定位置停止。

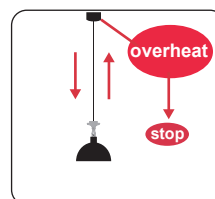

过热保护功能

当升降器电机因连续操作而过热时，升降动作自动停止，直到升降器电机温度冷却后，又重新升降动作。

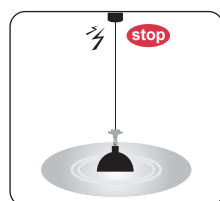

无负荷感应装置

当升降器接触地板或被障碍物抓住而没有检测到负载时，升降操作会自动停止。



圆形触点

圆形触点具有弹性，面积大，导电性极强。



Move It! It's Possible!

照明升降器

可在地面安全地对灯具进行维护维修



No danger!

无需爬高，无需高空作业，可预防高空事故的发生。



No equipment!

无需租用高昂的升降设备，在地面便可对灯具进行维护清洁。



No electric shock!

升降器下降操作时，会自动断电，因此无触电危险。



Safe!

因在地面进行维护清洁，十分安全。



Save cost!

在维修时，无需停电停产，可防止因停产造成的损失，节约维修成本。



Fast!

使用升降器维修时，可缩短维修时间，必要时可立即进行检查。



工厂

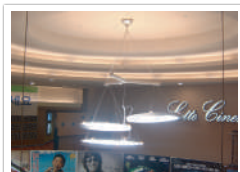

电影院



室内体育馆

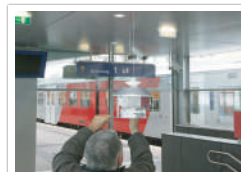

地铁站

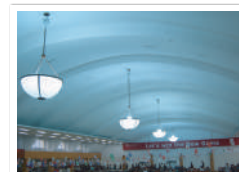

公司食堂



公寓



寺庙

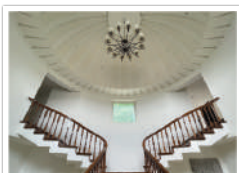

别墅

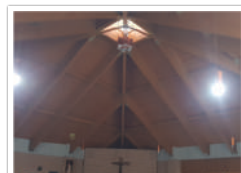



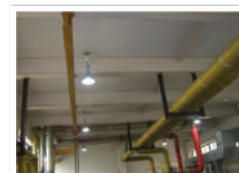



教堂









污水处理厂

● 照明升降器

* 可根据使用高度定制

产品						
型号	MSI-3	MDI-5	CSI-12	CDI-15	HSI-18	HDI-25
产品规格(mm)	162.2(W)*170(H)		140(W)*140(D)*216(H)		175(W)*175(D)*228(H)	
产品重量(kg)	2.2kg	2.2kg	3.1kg	3.13kg	6.6kg	6.69kg
可承载重量(kg)	1~3kg	2~5kg	3~10kg	3~15kg	3~15kg	6~25kg
可升降高度(M)	15M	7M	15M	7M	15M	7M
钢丝绳数量	1	2	1	2	1	2
钢丝绳直径	1.2mm	1.2mm	1.4mm	1.2mm	2.0mm	1.6mm
照明额定电流	16A	16A	16A	16A	16A	16A
电机	DC Motor	DC Motor	DC Motor	DC Motor	DC Motor	DC Motor

产品								
型号	PSI-20	PDI-35	PSI-30	PDI-50	PFI-100	PFI-200	PFI-300	PFI-500
产品规格(mm)	209(W)*209(D)*276(H)		209(W)*209(D)*276(H)		410(W)*410(D)*635(H)			
产品重量(kg)	7.63kg	7.63kg	8.44kg	8.44kg	57.5kg	58kg	58kg	59kg
可承载重量(kg)	4~20kg	8~35kg	4~30kg	8~50kg	50~100kg	60~200kg	100~300kg	100~500kg
可升降高度(M)	15M	7M	15M	7M	30M	20M	20M	15M
钢丝绳数量	1	2	1	2	4	4	4	4
钢丝绳直径	2.4mm	2.0mm	2.4mm	2.0mm	3.0mm	4.0mm	4.0mm	5.0mm
照明额定电流	16A	16A	16A	16A	32A	32A	32A	32A
电机	DC Motor	DC Motor	BLDC Motor	BLDC Motor	BLDC Motor	BLDC Motor	BLDC Motor	BLDC Motor



火车站

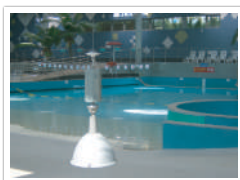

游泳馆

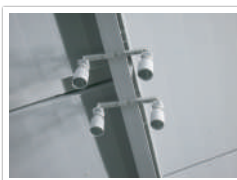

机场

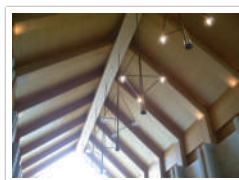

公寓

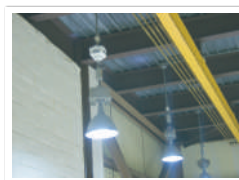

发电站

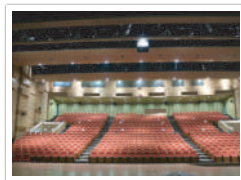

政府综合大楼礼堂



会议厅



大型购物中心



物流中心

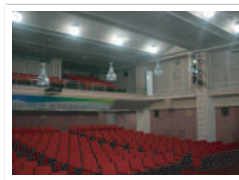

文化艺术中心



多功能礼堂



屏蔽室

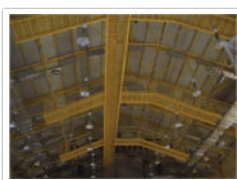

青少年训练中心



门球场



军事基地



Move It! It's Possible!

LED & 升降LED

优势



绿色环保产品



高效认证



KC认证



KS认证



节省维护费用



节能



便利性

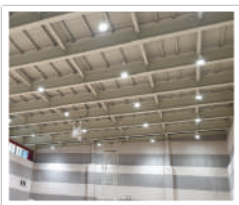
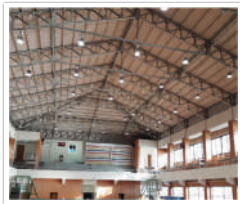

LED

* 可根据使用高度定制

产品			
型号	RT-LEDN150	RT-LEDN200	CSI-LH200
产品规格(mm)	244(W) x 158(H)	244(W) x 158(H)	244(W) x 370(H)
产品重量(kg)	3.1kg	3.1kg	9.3kg
产品功率	150W	200W	200W
功率因数	0.95	0.96	0.96
初始光通量	18778lm	24893lm	24893lm
色温 CCT	5650K	5656K	5656K
显色指数CRI	77	77	77
输入电压	220V/60Hz	220V/60Hz	220V/60Hz

升降LED

▼ 保修8年 (40,000小时以内)

产品						
型号	MSI-LN150	MSI-LN200	CSI-LN150	CSI-LN200	CSI-7D150	CSI-7D200
产品规格(mm)	244(W) x 285(H)	244(W) x 285(H)	244(W) x 329(H)	244(W) x 329(H)	244(W) x 344(H)	244(W) x 344(H)
产品重量(kg)	5.3kg	5.3kg	6.2kg	6.2kg	6.2kg	6.2kg
可承载重量(kg)	1~3kg	1~3kg	2~7kg	2~7kg	2~7kg	2~7kg
可升降高度(M)	15M	15M	15M	15M	15M	15M
钢丝绳数量	1	1	1	1	1	1
钢丝绳直径	1.2mm	1.2mm	1.4mm	1.4mm <td 1.4mm	1.4mm	
电机	DC Motor	DC Motor	DC Motor	DC Motor	DC Motor	DC Motor
触点数量	2	2	2	2	8	8

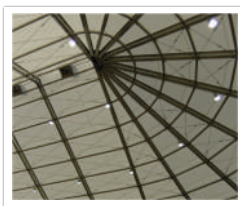
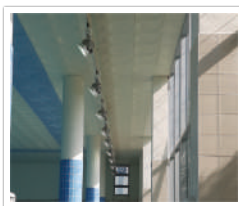
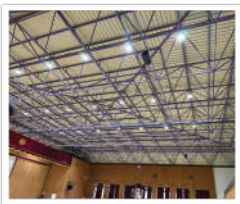
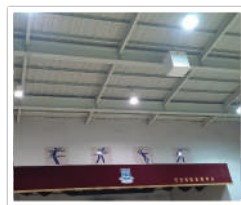



Move It! It's Possible!

插座升降器

● 把很长的电线嵌入安装在顶棚里，需用时从空而降！



✓ 在学校

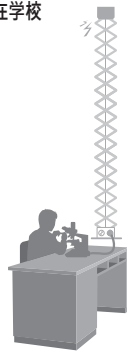

✓ 在工厂

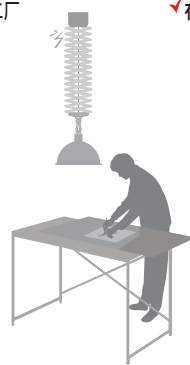

✓ 在家里

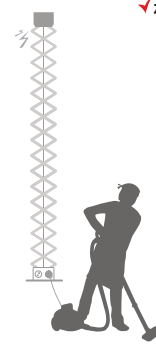

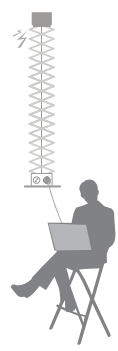

✓ 在办公室



● 插座升降器

* 可根据使用高度定制

产品					
型号	LSI-7	LSI-10	LSI-PS	LSI-3	LDI-3
产品规格(mm)	300(W)*235(D)*570(H)	140(W)*140(D)*529(H)	440(W)*220(D)*296(H)	228(W) x 228(D) x 301(H)	
产品重量(kg)	8.5kg	6.7kg	4.7kg	6.1kg	6.83kg
可承载重量(kg)	-	3~7kg	10kg~	-	-
可升降高度(M)	2M	2M~	2M~	2M/最大7M(可定制)	2M/最大3M(可定制)
钢丝绳数量	1	1	1	1	2
钢丝绳直径	1.4mm	1.4mm	1.4mm	-	-
额定电流	16A	16A	16A	16A	16A
电机	DC Motor	DC Motor	-	DC Motor	DC Motor

升降插座的多种应用

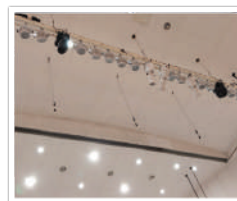
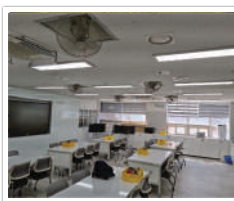
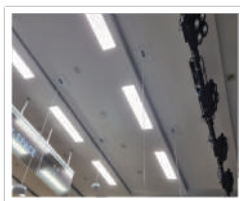
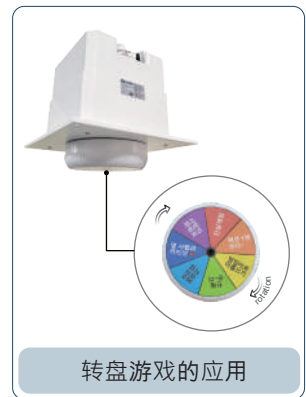



Move It! It's Possible!

多触点升降器

● 在需要固定方向性的方形照明或CCTV、音响、DALI等产品中使用

8个触点(单丝)



- ① —— 信号 1
- ② —— 信号 2
- ③ —— 信号 3
- ④ —— 信号 4
- ⑤ —— 地线 (绿/黄)
- ⑥ —— 电源 (L-灰色)
- ⑦ —— 电源 (N-蓝色)
- ⑧ —— 空闲触点

6个触点(双丝)



- ① —— 电源 (N-蓝色)
- ② —— 电源 (L-灰色)
- ③ —— 信号 1
- ④ —— 信号 2
- ⑤ —— 信号 3
- ⑥ —— 信号 4

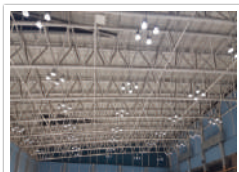

室内羽毛球场

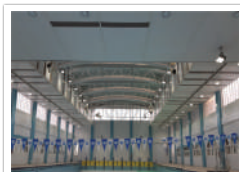

游泳馆



网球场



多功能体育馆

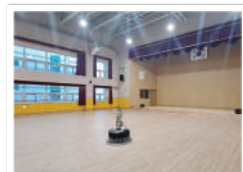

学校礼堂

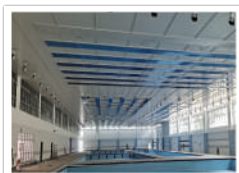

游泳馆

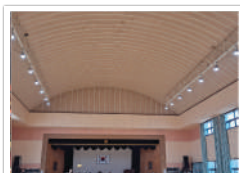

多功能体育馆



多功能体育馆







学校礼堂



多功能体育馆

● 多触点升降器

* 可根据使用高度定制

产品				
型号	MSI-1M	MDI-5M	CSI-12M	CDI-15M
产品规格(mm)	162(W) x 176.5(H)	162(W) x 176.5(H)	140(W) x 140(D) x 221(H)	140(W) x 140(D) x 221(H)
产品重量(kg)	2.2kg	2.2kg	3.1kg	3.13kg
可承载重量(kg)	1kg	2~5kg	3~10kg	3~15kg
可升降高度(M)	15M	7M	15M	7M
钢丝绳数量	1	2	1	2
钢丝绳直径	1.2mm	1.2mm	1.4mm	1.2mm
照明额定电流	16A	16A	16A	16A
电机	DC Motor	DC Motor	DC Motor	DC Motor

产品						
型号	HSI-18M	HDI-25M	PSI-20M	PSI-30M	PDI-35M	PDI-50M
产品规格(mm)	175(W) x 175(D) x 251(H)	175(W) x 175(D) x 251(H)	209(W) x 209(D) x 298(H)	209(W) x 209(D) x 298(H)	209(W) x 209(D) x 298(H)	209(W) x 209(D) x 298(H)
产品重量(kg)	6.6kg	6.69kg	7.63kg	8.44kg	7.63kg	8.44kg
可承载重量(kg)	3~15kg	6~25kg	4~20kg	4~30kg	8~35kg	8~50kg
可升降高度(M)	15M	7M	15M	15M	7M	7M
钢丝绳数量	1	2	1	1	2	2
钢丝绳直径	2.0mm	1.6mm	2.4mm	2.4mm	2.0mm	2.0mm
照明额定电流	16A	16A	16A	16A	16A	16A
电机	DC Motor	DC Motor	DC Motor	BLDC Motor	DC Motor	BLDC Motor

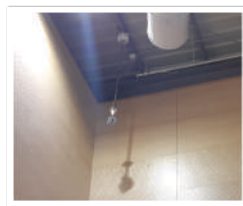
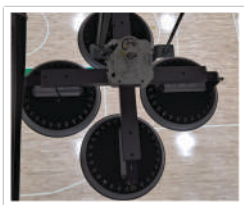



Move It! It's Possible!

火灾检测升降器

● 火灾检测升降器

* 可根据使用高度定制

产品		
型号	FSI-1	MSI-1M
产品规格(mm)	162(W) x 151(H)	162(W) x 176.5(H)
产品重量(kg)	2.2kg	2.2kg
可承载重量(kg)	1kg	1kg
可升降高度(M)	15M	15M
钢丝绳数量	1	1
钢丝绳直径	1.2mm	1.2mm
电机	DC Motor	DC Motor



变电站

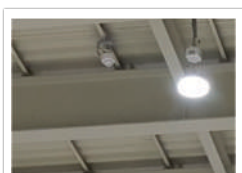

学校礼堂



学校礼堂

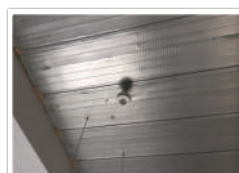

变电站

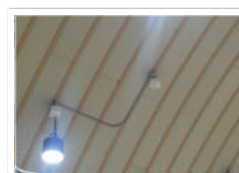

学校礼堂



● 宣传横幅，太极旗，空气循环设备，大型宣传物，舞台照明等应用

同步升降器 两台升降器同时升下降

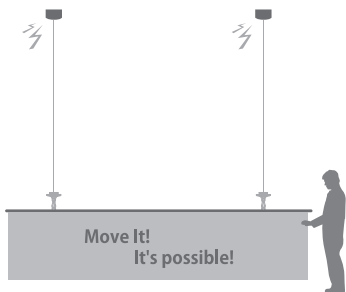

多触点同步升降器 3台以上升降器同时升下降

-  小巧型
-  挂钩型
-  强力型
-  超强力型

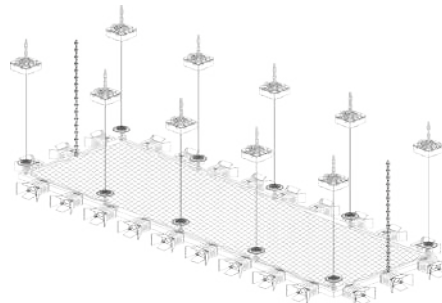

▲ 所有型号都适用

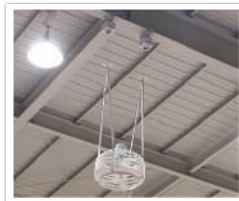
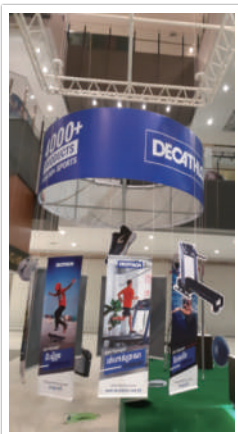
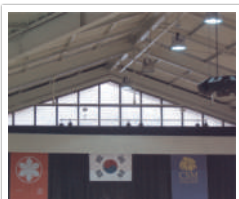



Move It! It's Possible!

CCTV升降器

为什么需要使用CCTV升降器？

清洁CCTV镜头

随时确保录像画质清晰

使用CCTV升降器定期清洁CCTV镜头，可以始终确保录像画质清晰。



镜头清洁前



镜头清洁后

安全维护维修CCTV

预防工伤

无需爬高在地面就可以对CCTV进行清洁和维护，因此可预防坠落事故的发生



高空作业：危险





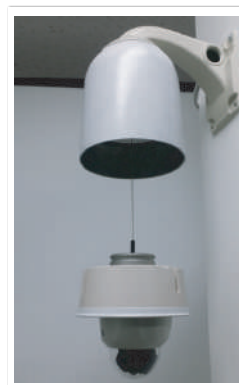



地面作业：安全



● CCTV升降器

* 可根据使用高度定制

产品				
型号	MSI-1CH	MDI-5CH	CSI-7CH	CDI-12CH
产品规格(mm)	185.4(W) x 208.8(H)	185.4(W) x 208.8(H)	248(W) x 292(H)	248(W) x 292(H)
产品重量(kg)	3.7kg	3.7kg	6.2kg	6.2kg
可承载重量(kg)	1kg	2~5kg	2~7kg	3~12kg
可升降高度(M)	15M	7M	15M	7M
钢丝绳数量	1	2	1	2
钢丝绳直径	1.2mm	1.2mm	1.4mm	1.2mm
触点数量	8	6	8	6
电机	DC Motor	DC Motor	DC Motor	DC Motor

产品		
型号	HSI-12CH	HDI-25CH
产品规格(mm)	248(W) x 292(H)	248(W) x 292(H)
产品重量(kg)	10kg	10kg
可承载重量(kg)	3~12kg	6~25kg
可升降高度(M)	15M	7M
钢丝绳数量	1	2
钢丝绳直径	2.0mm	1.6mm
触点数量	8	6
电机	DC Motor	DC Motor

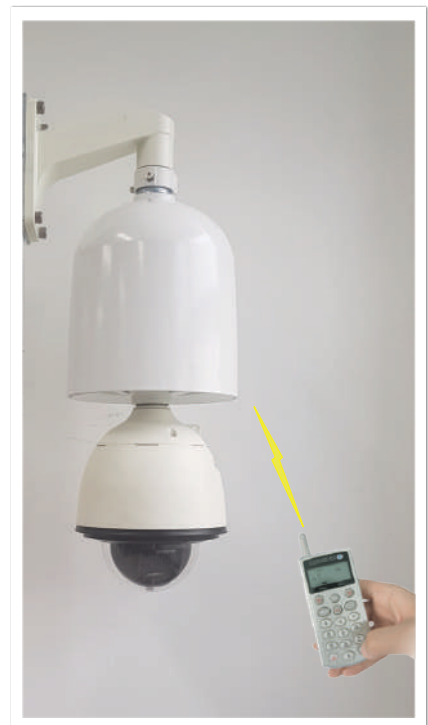
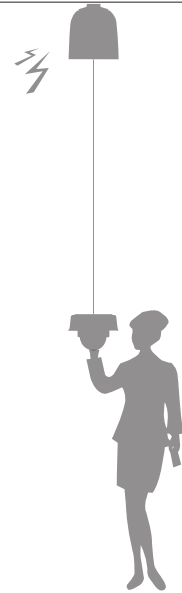



Move It! It's Possible!



横幅&屏风&防疫隔离板

宣传 & 防飞沫 & 保护隐私

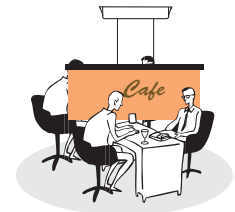
适用于餐厅、咖啡馆、公司办公室、会议室、宴会厅、大会议厅等场所使用



● 横幅&屏风&防疫隔离板

产品			
型号	BDL-2	BDL-2D	BDL-4D
产品规格(mm)	352.3(W) x 77.7(D) x 56(H)	213.3(W) x 77.7(D) x 56(H) * 2EA	352.3(W) x 77.7(D) x 56(H) * 2EA
产品重量(kg)	3.1kg	3.1kg	6.2kg
可承载重量(kg)	~2kg	~2kg	~2kg
可升降高度(M)	4M	4M	4M
钢丝绳数量	2	2	4
钢丝绳直径	0.8mm	0.8mm	0.8mm
额定电流	0.04A	0.04A	0.04A
电机	AC Motor	AC Motor	AC Motor





升降槽 GRILL LIFTER

Move It! It's Possible!

● 用于清洁中央空调滤网的升降产品

中央空调滤网如果长时间不清洁维护，空调效率就会下降，制冷效果差还容易发生故障，因此需要定期清洁过滤网

产品	
型号	GFL-3
产品规格(mm)	126(W) x 40(D) x 36(H)
产品重量(kg)	0.5kg
可承载重量(kg)	2kg
可升降高度(M)	4M
钢丝绳数量	2
钢丝绳直径	0.8mm
额定电流	0.6A
电机	DC Motor

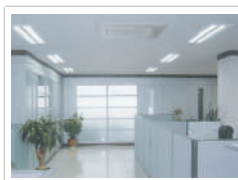
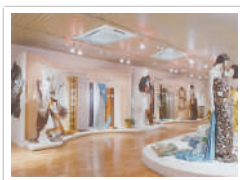
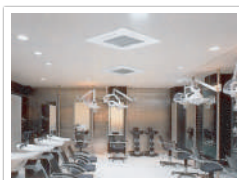
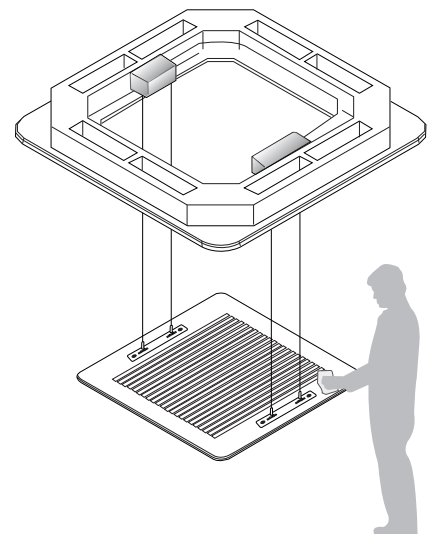



空气循环风扇升降器 & 无线传感器 & 无线开关

空气循环风扇升降器

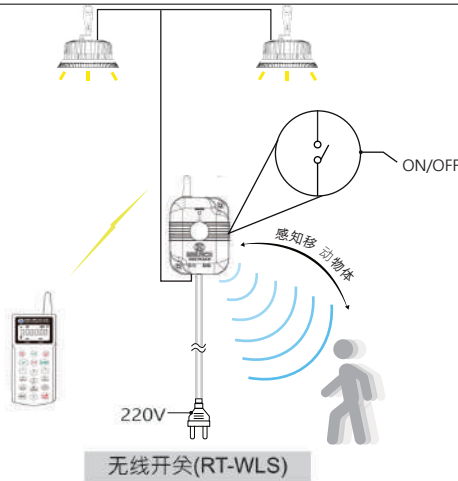

无线传感器 & 无线开关

产品		
型号	RT-WS	RT-WLS
产品规格(mm)	57.3(W)x38.2(D)X78.2(H)	70(W)x41(D)X92(H)
感知距离	5~7mm	5~7mm
使用温度	-20°C~+60°C	-20°C~+60°C
控制数量	最多100万台	最多100万台
特征	<ul style="list-style-type: none"> - 接受遥控信号后, 用升降器控制照明开关。 - 无线传感器通过感知移动物体时, 用升降器来控制照明开关。 - 没有感知移动物体时, 一定时间后会自动关闭(可设置1~99分钟)。 	<ul style="list-style-type: none"> - 接收遥控信号或者感知移动物体时, 无线开关自动控制照明的开关。
工作原理	 <p>无线传感器(RT-WS)</p>	 <p>无线开关(RT-WLS)</p>



※ 旋转部是上下压缩结构，非常坚固

加入RE100国际环境倡议

全球第一款一体型追踪装置

提高33%的发电量↑

超便宜

无故障

易安装

特征

- 360° 旋转 触点连接方式
- 太阳能自主供电系统
- GPS编程追踪方式

场所

- 可安装在庭院及围栏周围闲置土地
- 各种地形都适合安装
- 支持农光互补，有驱赶野猪功能



6张太阳能板



3张太阳能板



Move It! It's Possible!

太阳能升降安防灯杆

● 太阳能升降监控安防灯杆

- ✓ 可预防犯罪的设备
- ✓ 不需要施工供电，可以自主发电的优势
- ✓ 1天的用电量300W = 1小时的发电量 OK!

防范农田农产品盗窃及蓄意破坏的犯罪行为

安装在村口、农田、水塘等场所，可预防盗窃的犯罪行为



[全国农产品盗窃损失统计]

预防城市犯罪

安装在城市容易发生犯罪的地区(公园、偏僻窄道)可预防犯罪行为的发生。

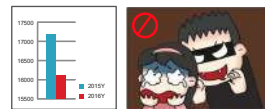

[清州市, 安装位置关系后设计数据]

预防学校暴力

安装在学校内及周边地区(卫生间及道路周边), 可预防学校暴力

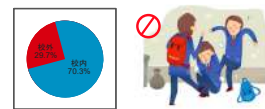



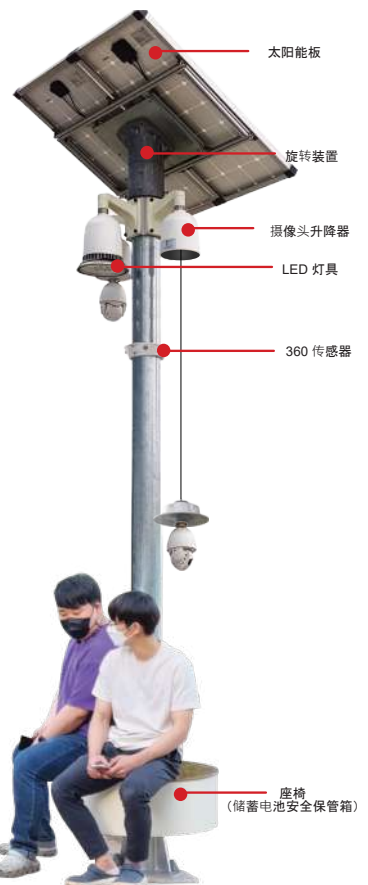

[校園暴力设计数据]







● 认证及专利



● 太阳能升降安防灯杆

构成				
名称	追踪装置	太阳能板	升降 CCTV	LED
规格	260 x 360 x 180mm(内径140mm) 14.5kg	1306 x 660 x 40mm 240W以上	15m 升下降 CCTV(SD卡) 无线监视功能 (WiFi)	50W 效率 : 141.5lm/W 显色性 : 77.5
特征	- 无电线触点连接方式 (触点寿命 20年保障) - 360度 旋转 - GPS+程序控制方式	- CE, RoHS 认证产品 - 高效单晶电池 - 高效转换率	- 完成风洞试验 (30ms以上) - 定期清洁镜片, 确保录像画质清晰 - 维护安全便利	- 符合广播通讯设备合格基准 - 符合公共采购的最低绿色标准 - Dimming 功能

构成				
名称	360 传感器	蓄电池保管箱	蓄电池(太阳能专用)	灯杆
规格	感知距离5~7m	Φ670 x 276mm, 铁板	SB1000 12V-100AH 250次循环 充电/放电 免维护密封电池	3.5m, 6.0T pipe Φ139.8 x 4.85
特征	- 通过感知移动物体控制LED	- 休息椅子的应用 - 封闭不外漏, 有防盗效果 - 覆盖面采用耐热材料	- 轻松检查充电状态 (Magic Eye 指示灯) - 防止外火流入: 密封盖子 - 为防止短路使用保护隔板	热浸镀

● 适用场所



● 安装案例



主要业绩



北京首钢香格里拉酒店



北京育英中学



大亚湾核电站



企业餐厅



武汉机场



雄安动车所



生产车间

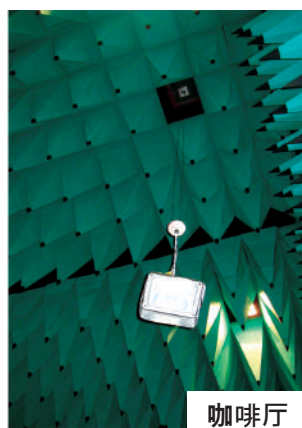

咖啡厅

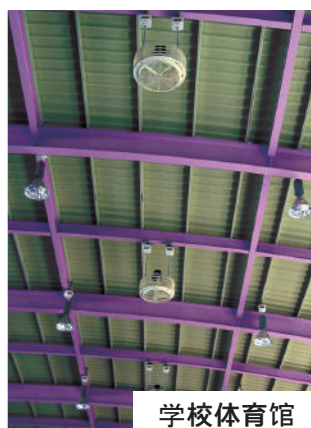

学校体育馆



商场



奥地利剧院



文莱皇宫



工厂

认证及专利

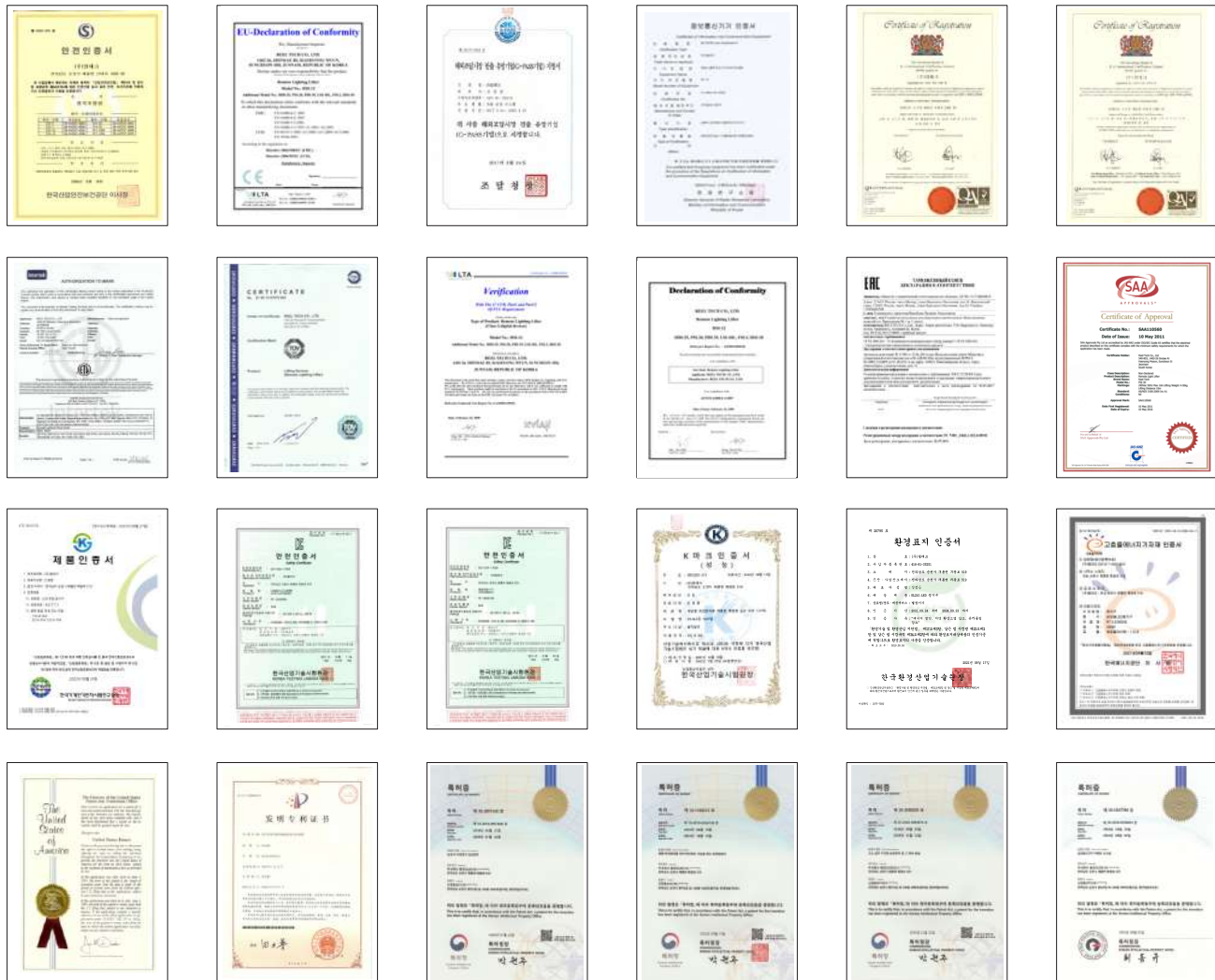



◆ 总公司

(株) REELTECH TEL : 061) 723-1113 FAX : 061) 723-4440 E-mail : reel-tech@hanmail.net <http://www.reeltech.co.kr>

◆ 国内代理店

地区	公司名称	电话	传真	网址	邮箱
首尔、仁川	reeltech Seoul Incheon Branch	032-812-4023	032-812-4024	www.reeltech.co.kr	sbj00@hanmail.net
京畿道	Seongwontop	010-9632-3578		www.reeltech.co.kr	swt9876@hanmail.net
江原道, 庆尚道, 蔚山、釜山	Hanbit enertech	052-991-7640~1	052-991-7642	www.reeltech.co.kr	hb7640@daum.net
忠清道, 世宗市、大田	RGB tech	070-8880-9183	050-4060-9183	www.reeltech.co.kr	ljm99@daum.net
全罗北道	Esseleenc	063-224-4694	050-4461-4694	www.reeltech.co.kr	it0153@nate.com
全罗南道, 光州	KSTech	061-725-9964	061-724-9964	www.reeltech.co.kr	kstech3885@hanmail.net
济州岛	e2z	064-748-8446	064-748-8445	www.reeltech.co.kr	lenado@e2z.co.kr

◆ 海外独家代理店及销售店

地区	公司名称	电话	传真	网址	邮箱
俄罗斯	PLATAN LLC	7(495)97-000-99		www.platan.ru	info@platan.ru
英国	REELTECH UK LTD.	+44(0)1604 643522	+44(0)1604 697028	www.reeltechuk.com	enquiries@reeltechuk.com
意大利	Santenini S.r.l	+39 0331 924846	+39 0331 920606	www.santenini.it	daniele.serventi@santenini.it
德国	REEL TECH Vertriebs GmbH	+49(0) 6109 / 5016151	+49(0) 6109 / 5016150	www.reeltech.de	office@reeltech.de
奥地利	REEL TECH Vertriebs GmbH	+49(0) 6109 / 5016151	+49(0) 6109 / 5016150	www.reeltech.de	office@reeltech.de
瑞士	REEL TECH Vertriebs GmbH	+49(0) 6109 / 5016151	+49(0) 6109 / 5016150	www.reeltech.de	office@reeltech.de
新加坡	LIGHTCRAFT PTE LTD	+65 6744 2441	+65 6744 1416	www.lightcraft.com.sg	enquiry@lightcraft.com.sg
科威特	YOUSEF AL-AHMAD INT GROUP	+965 24821302	+965 24847725	www.alahmedgroup.com	info@alahmedgroup.com
巴林	Genprise Co. W.L.L.	+973 17311442	+973 17311019/17910761	www.genpriseco.com	info@genpriseco.com
法国	MINOEUROPE SARL	+33 6 22 70 43 45			Haemaru.ryu@minoeurope.com
墨西哥	AG Lighting SA de CV	+(52) (55) 6845-6002		www.aglighting.mx	contacto@aglighting.mx
哥伦比亚	ZONA DE ENFOQUE NETWORK S.A.S	+57 314 892 53 17		www.reeltechcolombia.co	gerencia@reeltechcolombia.co
伊朗	BHE CO.	+98 713 648 0010	+98 713 648 0011	www.inenop.com	s.Afsar@bhe-co.com
中国	SHENZHEN PHIAN S	+86 755 8621 8116		www.nuclearscm.com	1309582350@qq.com
中国	TIANJIN CHUANGFA TECHNOLOGY	+86 22 2368 9010			13920555675@163.com
中国	Txzj(WuHan) Technology	+86 138-7123-9075			2024225975@qq.com
香港	Lightcraft Limited	+852 2866 6965		www.lightcraftintl.com	info@lightcraft.asia